

Getting  
Creative  
with

**Pororo**  
The Little Penguin

3

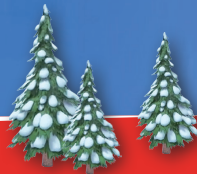

# Pororo Makes His Mark



KIPPO



WIPO

kipa.

ocon  
STUDIOS

## Episode

Pororo was busy building his sled when some friends come along asking for help with their broken sled. After carefully inspecting the sled, Pororo realizes it was not one of his. He then creates the “Porong-Porong Super Sled” and sticks his labels on his sled. Later on, Pororo’s friends who want the Porong- Porong Super Sled gather at his house.

This episode explains that the function of a trademark is to distinguish one product from another, and shows the process of developing a trademark as well.

It also highlights the fact that proper use of trademarks is beneficial to consumers as well as manufacturers.



## Lesson Objectives

- To understand trademarks.
- To understand why we need trademarks.
- Invent trademarks and apply them.

Getting  
Creative  
with

**Pororo**  
The Little Penguin

3



**Pororo  
Makes  
His Mark**

**Workbook**

**Pororo and his friends invented the sled. There are two jet-propelled sleds, one made by the Rabbit Twins and the other by Pororo and his friends.**



Observe the two sleds carefully to decide which one has been made by Pororo and circle it.

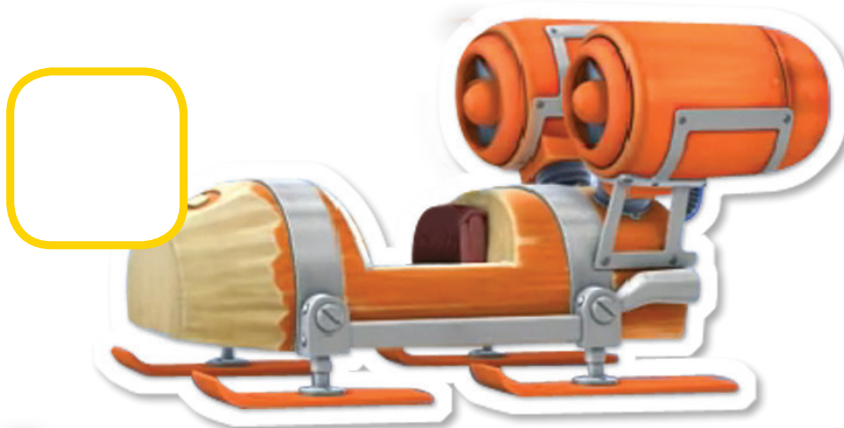
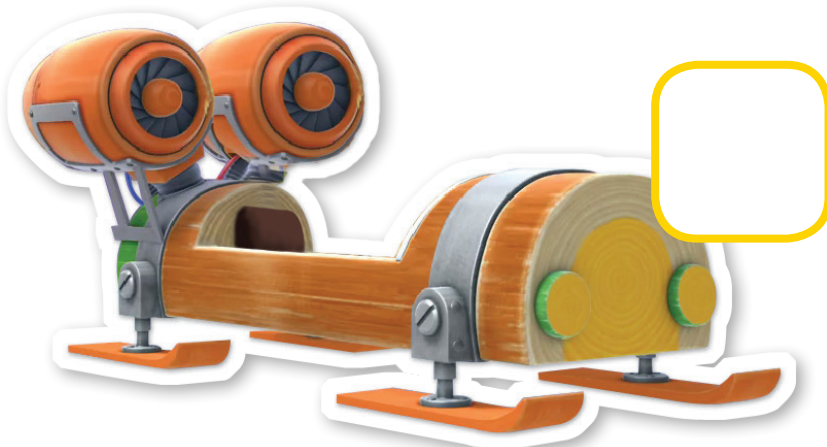

# Pororo Makes His Mark **3**

Pororo and his friends have decided to give their sled a name as a trademark. At the beginning they thought of names like Airplane or Prettiest Sled or Fast Fast.



Unfortunately these names cannot be used as a trademark. Think about why not and draw lines to connect them with appropriate reasons.

**Superjet**

This trademark sounds like a description, rather than a sign of origin.

**Prettiest Sled**

This trademark is vague and could confuse people as to the nature of the product.

**Velocity**

This trademark just describes a quality of all sleds.

**Pororo and his friends have decided to use the trademark for the sled they have invented: the 'Porong-Porong Super Sled'.**



What part of the sled did 'Porong-Porong' remind them of?  
Let's show it in the picture below.

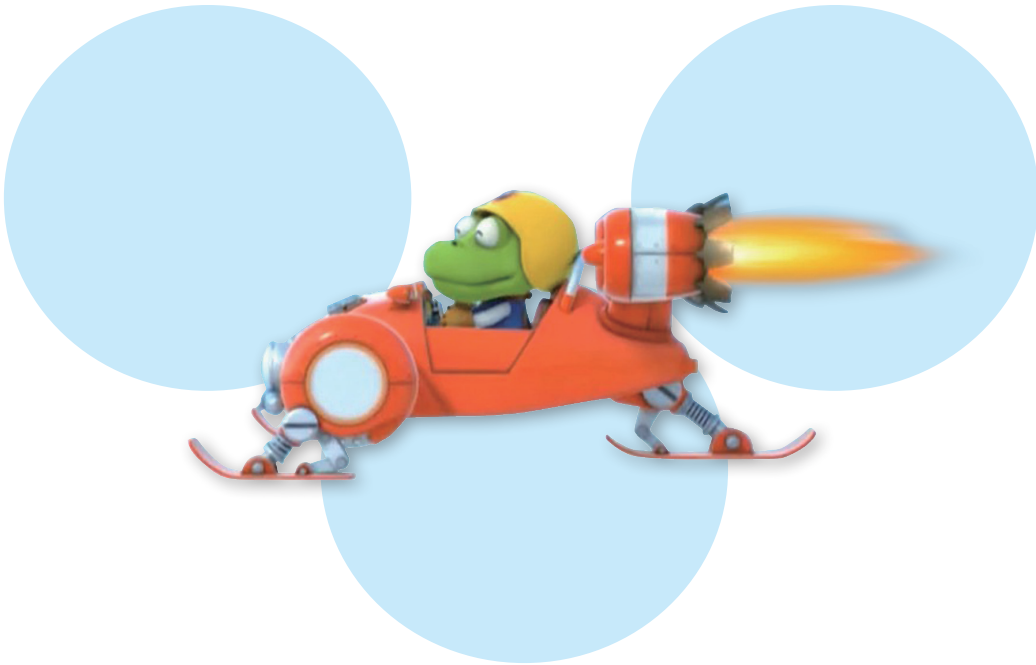

Try expressing the engine sound from the sled in ways other than 'Porong-Porong'.

# Pororo Makes His Mark **3**

**A trademark needs to show clearly the characteristics of invented goods (product).  
What will make a good trademark?**



Match goods with the corresponding sound.

**slurp**



**hiss**

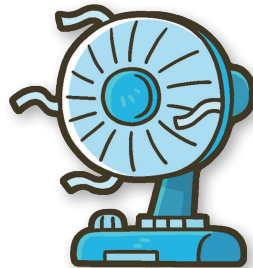

**vroom**

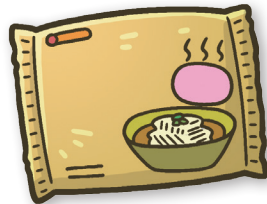

Choose from the conditions below which are good and which are bad in a trademark.

	good	bad
1 Easy to pronounce	<input type="checkbox"/>	<input type="checkbox"/>
2 Nothing special	<input type="checkbox"/>	<input type="checkbox"/>
3 Similar to famous trademarks	<input type="checkbox"/>	<input type="checkbox"/>
4 Easy to write	<input type="checkbox"/>	<input type="checkbox"/>
5 Easy to read	<input type="checkbox"/>	<input type="checkbox"/>
6 Literally descriptive	<input type="checkbox"/>	<input type="checkbox"/>
7 Easy to remember	<input type="checkbox"/>	<input type="checkbox"/>
8 Not clear	<input type="checkbox"/>	<input type="checkbox"/>
9 Difficult to say	<input type="checkbox"/>	<input type="checkbox"/>
10 Easily confused	<input type="checkbox"/>	<input type="checkbox"/>



# Pororo Makes His Mark 3

Which of the images below can be used as trademarks?

• STICKER 3-1



picture



shape

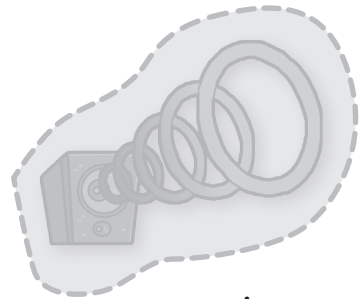

sound



word

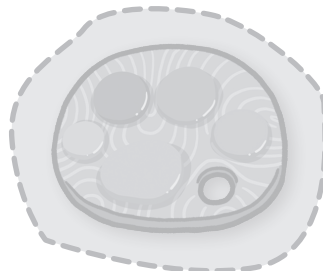

color



number

The trademark for Pororo's sled is 'Porong-Porong Super Sled'. Help Pororo invent a new trademark using pictures, numbers and different colors.



# Pororo Makes His Mark 3

Pororo and his friends have created a trademark and attached it to the sled they've invented. Let's think about what a trademark is and what it does.



Look around you and find trademarks on objects and draw them below.

1 2 3

Among the trademarks you have drawn, which is your favorite? Explain why.

-----  
-----  
-----

Look at the situation carefully and write in the bubble what you think will happen afterwards.



1

Oh! Pororo's sled. What is it?



2

if you use a trademark, people will not be confused.



3

A trademark?



4



# Pororo Makes His Mark **3**

The Porong-Porong Super Sled became so popular that many friends came to Pororo asking for the sled.



Which of the reasons given below explain why the Porong-Porong Super Sled is so popular?



Clearly distinguished from other sleds.



The trademark looks nice.



Pororo's popularity is high.

As the Porong-Porong Super Sled is becoming popular, what attitude do Pororo and his friend have? Fill in the blank in the cartoon below.

1

Pororo, I want to have the Porong-Porong Super Sled!



2

Me too! Me too!



3

All I did was add a trademark....



4

Look how popular the Porong-Porong Super Sled is. Now you must be responsible about your trademark and take good care.

( )  
Only then will people trust your sled.

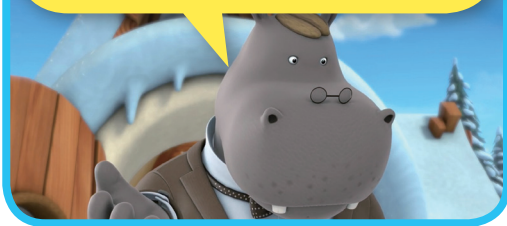

# Pororo Makes His Mark 3

**Pororo has invented a car that runs on water using the jet engine.**



Imagine the rest and complete the picture.

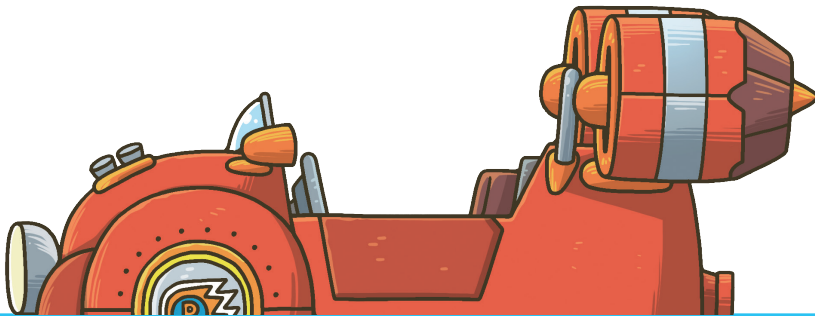

Pororo has made a car that runs on water; what trademark is suitable? Draw your own brand on the pictures below.

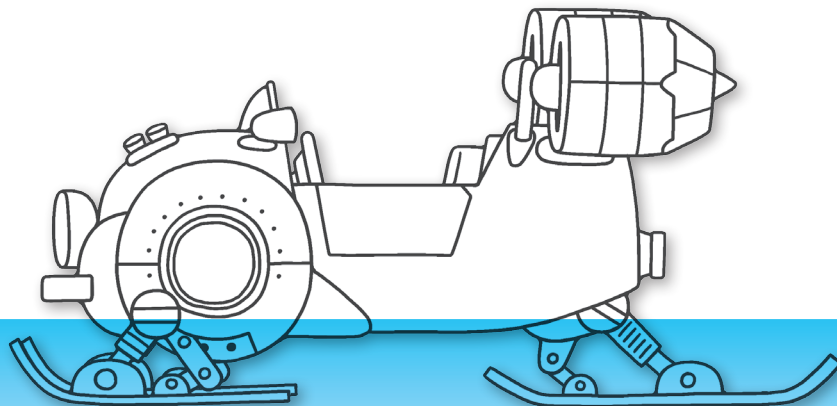
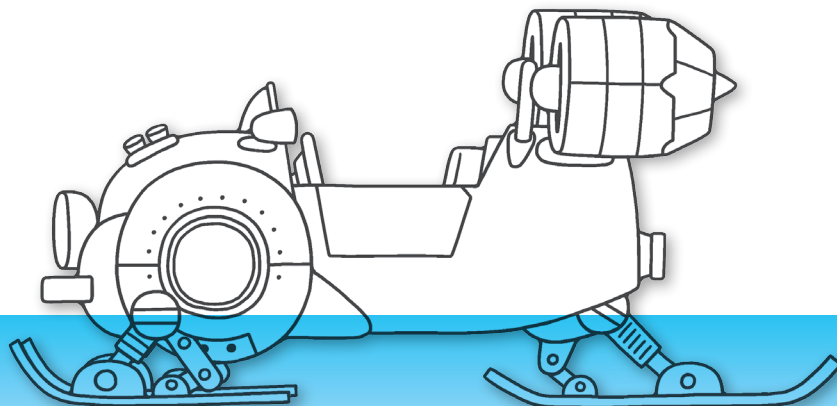







# LET'S MAKE A PORORO POP-UP CARD



## What you need

2 Pop-up Card Pattern Sheets, Scissors, Cutter knife, Ruler, Glue

Getting  
Creative  
with

**Pororo**  
The Little Penguin

3



**Pororo  
Makes  
His Mark**

**INVENTION  
KIT**

## Create a Pororo Pop-up Card yourself.



① Print 2 pattern sheets on both sides of a thick A4-sized sheet.



② Cut out part ①, and make a cut along the unbroken lines.



③ Cut out parts ②~④, and fold along the dotted lines.

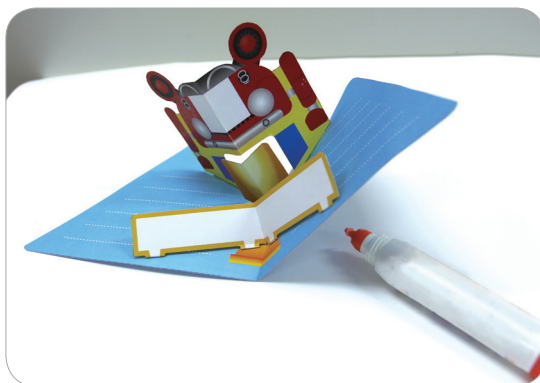

④ Combine ② to ③, and fix with glue.

# Pororo Makes His Mark 3

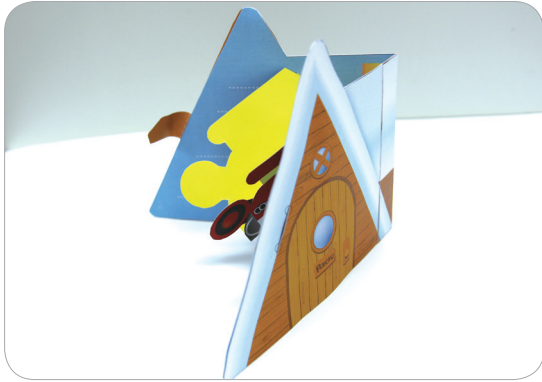

⑤ Put parts ⑤, ⑥ on the exterior of the card and fix them.



⑥ Done!



Let's make a brand of the pop-up card and short description to put on the name plate.

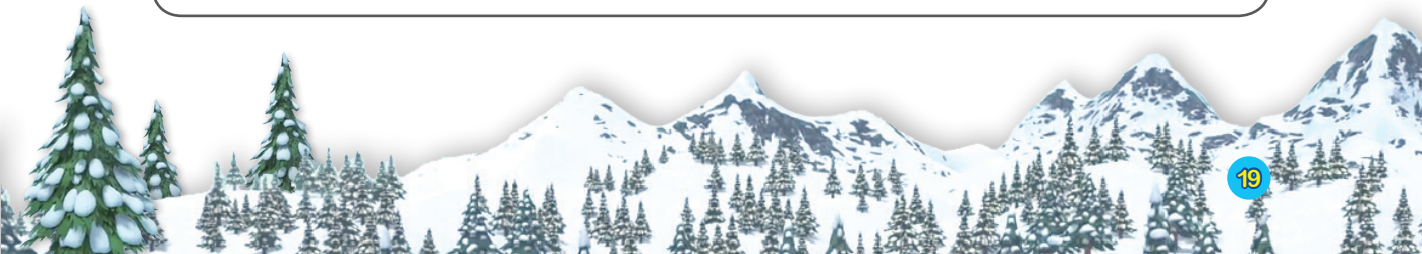

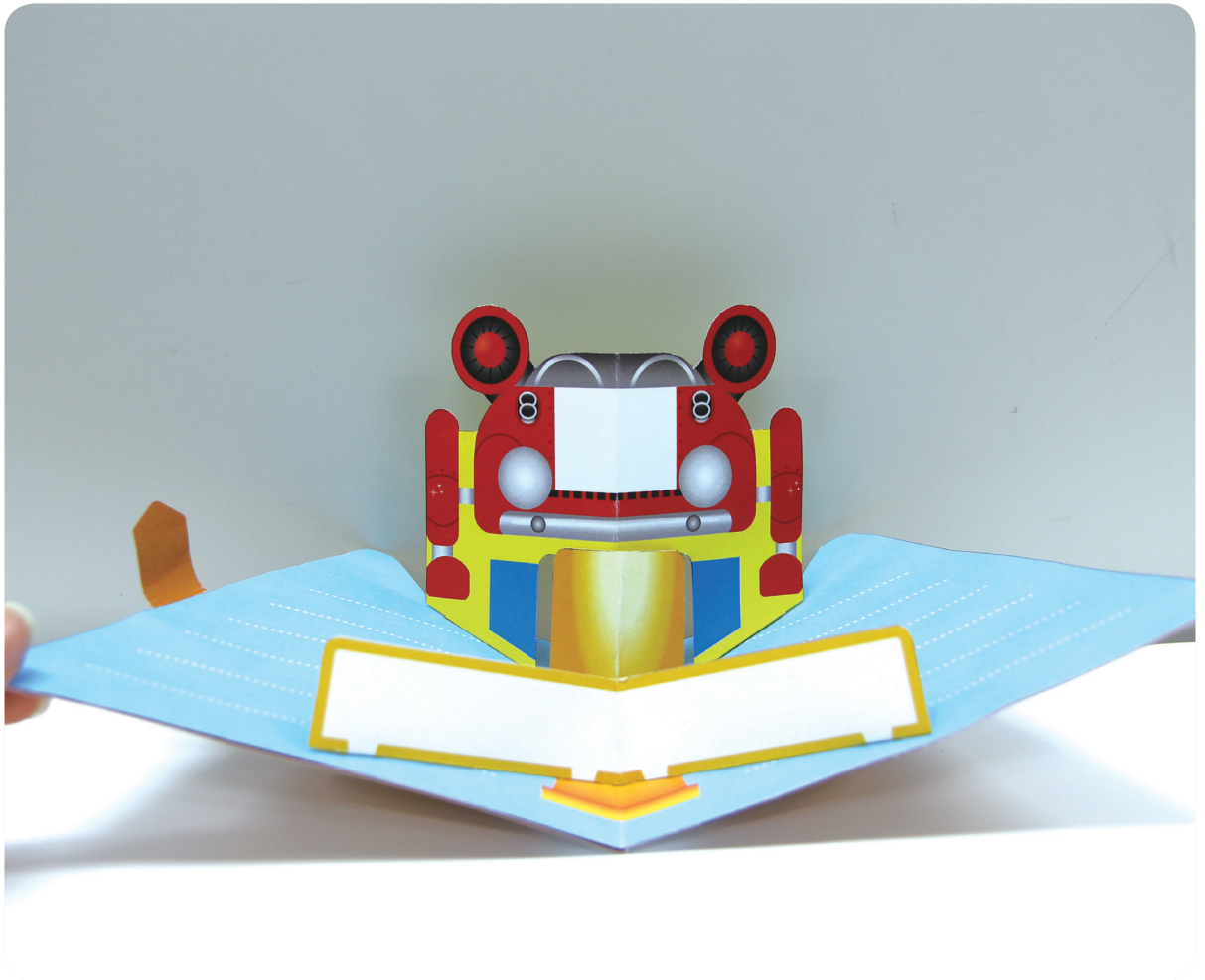

**Make your own  
pop-up card,  
filling out nameplate  
and tags.**





### Korean Intellectual Property Office

Government Complex Daejeon Building 4, 189, Cheongsu-ro,  
Seo-gu, Daejeon, 302-701, Republic of Korea

<http://www.kipo.go.kr/en>

Tel. +82 42 481 5072



### World Intellectual Property Organization

34, chemin des Colombettes, 1211 Geneva, Switzerland

<http://www.wipo.int>

Tel. +41 22 338 91 11



### Korea Invention Promotion Association

131, Teheran-ro, Gangnam-gu, Seoul, Korea 135-980

<http://www.kipa.org/english>

Tel. +82 2 3459 2811





# STICKER 3-1(7page)

